

Protecting the future

Atmospheric corrosion prevention
by STOPAQ



 **STOPAQ**

 **SEALFORLIFE**
Industries

Above Ground

STOPAQ is the ultimate technology to protect atmospheric pipework and other steel assets above ground from the effects of corrosion.

STOPAQ systems protect against the ingress of water, oxygen and bacteria, and strives to be the most environmentally-friendly corrosion prevention system in the world.

STOPAQ offers solutions for the following applications:

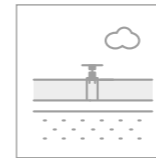

Atmospheric
Pipework

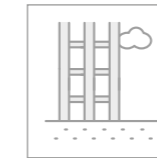

Atmospheric
Structures

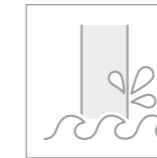

Splash
Zone

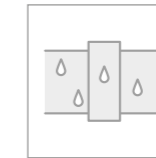

Condensing
Lines

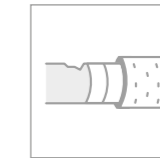

Corrosion
Under Insulation

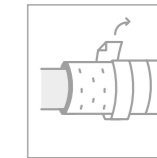

Insulation
Cladding and
Sealing

Protecting the future

The Adhesion Test

STOPAQ has superior adhesion to various substrates, dry or wet, with minimum surface preparation requirements. Without the need for primers or complex tools, our systems are simple and easy to apply.



Atmospheric and immersed we have the solution

Our product range is suitable for any structure and service condition from -45 to $+120$ °C / -49 to $+248$ °F.

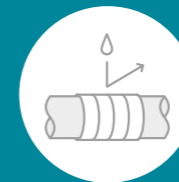

Wrappingband Products

Wrappingband and Basecoats form a permanent corrosion prevention layer.

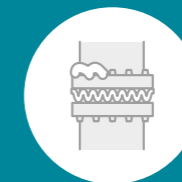

Paste and Filler Products

A series of mouldable Pastes and Fillers used to fill up irregular shapes and bevel all edges.

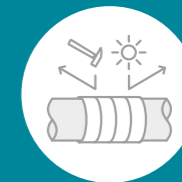

Mechanical Protection Products

A selection of Outerwraps or Topcoats adaptable to meet various performance requirements.

Protecting the future

Case: Braefoot Bay Bridge

Scotland has never been a place of predictable or favourable weather for product application. Shell therefore required a product with adhesion to low temperature substrates, with quick access to and from the job site.



Atmospheric Structures

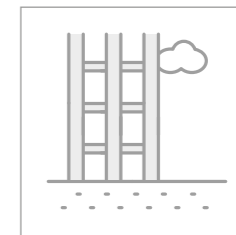

STOPAQ is the ultimate technology to protect atmospheric steel structures from the effects of corrosion.

STOPAQ Wrappingband and Basecoat products are corrosion preventative materials, adhering extremely well to bare and coated steel and can be complemented with an Outerwrap or a Topcoat for mechanical protection.

easy
application

Protecting the future

Atmospheric Pipework

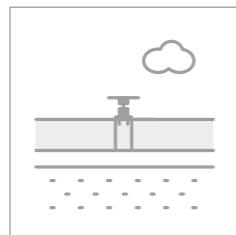

STOPAQ is the ultimate technology to protect atmospheric pipework from the effects of corrosion.

STOPAQ Wrappingband and Paste products are corrosion preventative materials, used to protect products such as pipelines, pipe-connections and flanges. They can be complemented with STOPAQ Outerwrap HSPEX or HTPP for mechanical protection.



Case: FPSO

For temperatures of up to 120 °C / 248 °F on process pipework, Equinor has approved Wrappingband CZHT system, tolerant to high surface temperature application topped by insulation and sound dampening properties.



Protecting the future

Splash Zone

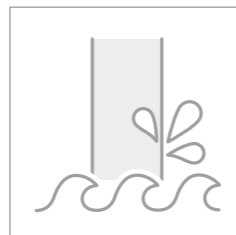

STOPAQ is the ultimate technology to protect steel structures from the effects of corrosion in the splash zone.

At tidal zones, Wrappingband WSH protects the object fully against the influence of (salt) water, bacteria, and oxygen. The wrappable material is especially designed for application on wet submerged, and can also be applied on dry substrates. Complemented with Outerwrap for sufficient mechanical protection.

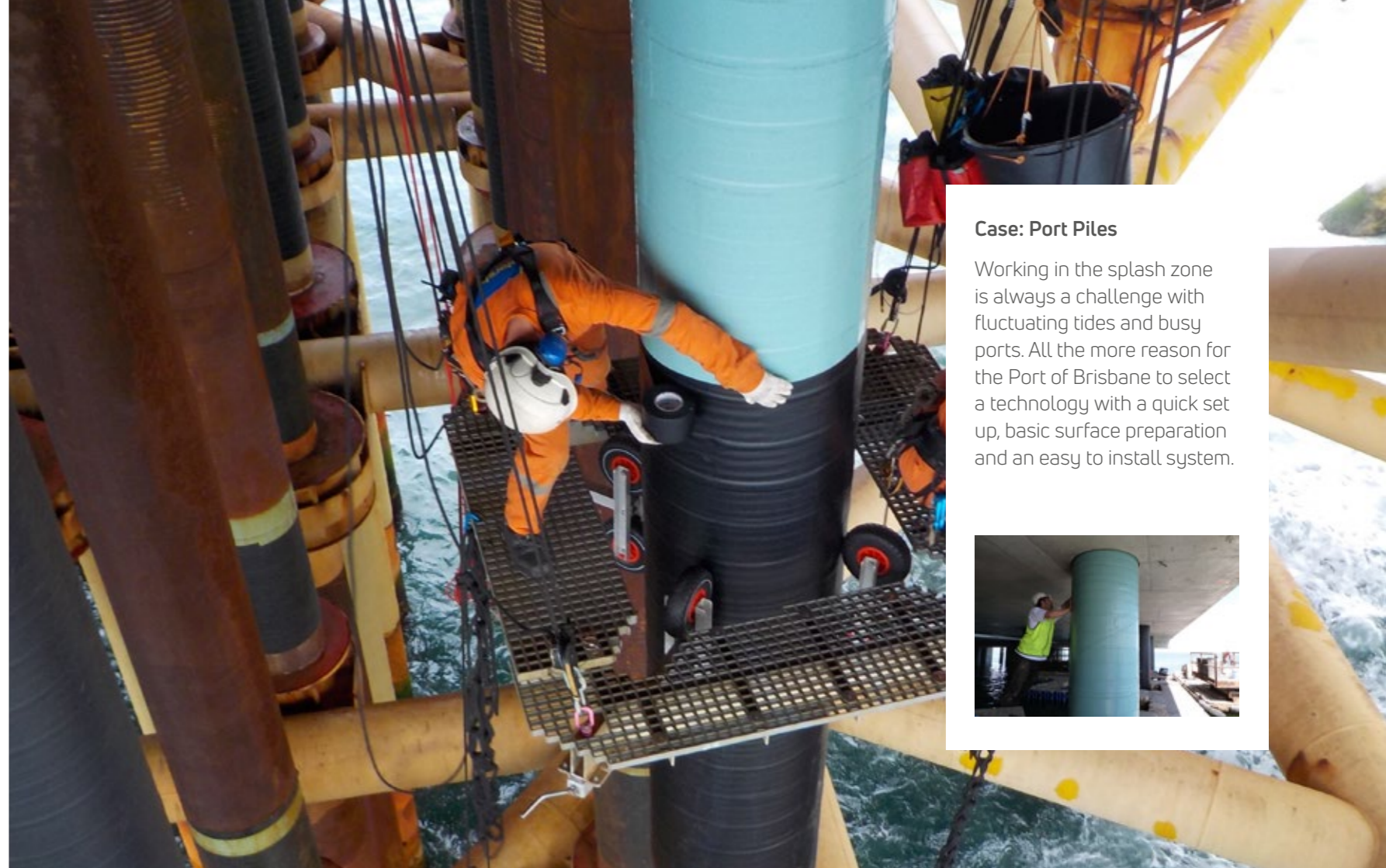

Case: Port Piles

Working in the splash zone is always a challenge with fluctuating tides and busy ports. All the more reason for the Port of Brisbane to select a technology with a quick set up, basic surface preparation and an easy to install system.



Protecting the future

Condensing Lines

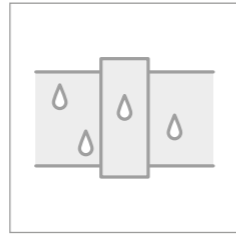

STOPAQ is the ultimate technology to protect condensing lines from the effects of corrosion.

The STOPAQ WSH productline are corrosion preventative materials, designed for application on damp surfaces.

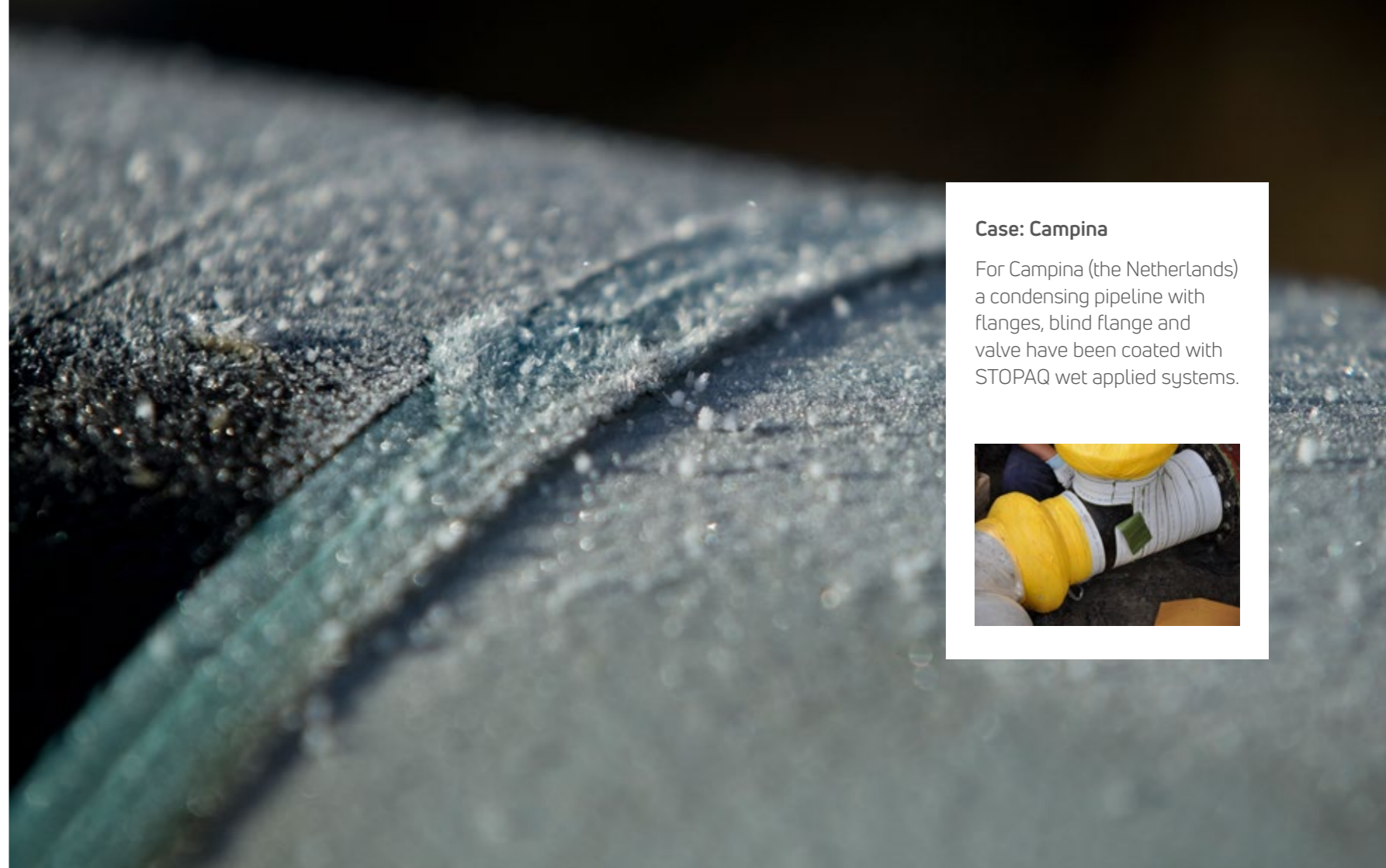

Case: Campina

For Campina (the Netherlands) a condensing pipeline with flanges, blind flange and valve have been coated with STOPAQ wet applied systems.



Front End Engineering

STOPAQ Front End Engineering Design (FEED) combines sealing & cladding in one system.

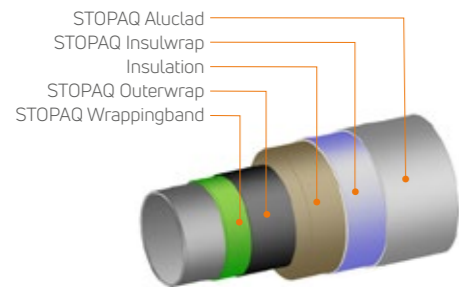

Under Insulation (CUI)

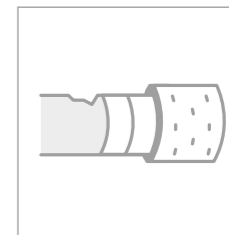

STOPAQ is the ultimate technology to protect pipework from the effects of Corrosion Under Insulation (CUI).

Our wide range of products prevents corrosion caused by fluids leaching from insulation, thermal shock and flue gasses and can be applied while in operation. STOPAQ Wrappingband CZHT and Outerwrap HTPP is a Shell DEP approved system to prevent CUI up to 120 °C / 248 °F.

Protecting the future

Front End Engineering

STOPAQ Front End Engineering Design (FEED) combines sealing & cladding in one system.

STOPAQ Aluclad
STOPAQ Insulwrap
Insulation
STOPAQ Outerwrap
STOPAQ Wrappingband

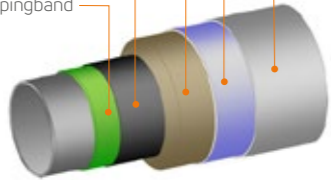

Over Insulation

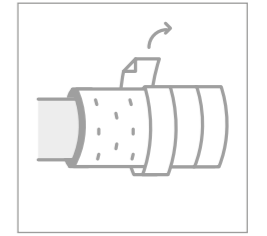

STOPAQ InsulWrap and AluClad are specially designed to seal the insulation on an asset.

STOPAQ InsulWrap provides a water vapour barrier over insulation. STOPAQ AluClad will ensure a watertight seal of cladding preventing ingress of water to the insulation. Both products have a self-extinguishing reaction to fire.



10+
million
square meters
of assets protected

Systems Overview Above Ground

Our product range has a suitable solution for any structure and service condition.*

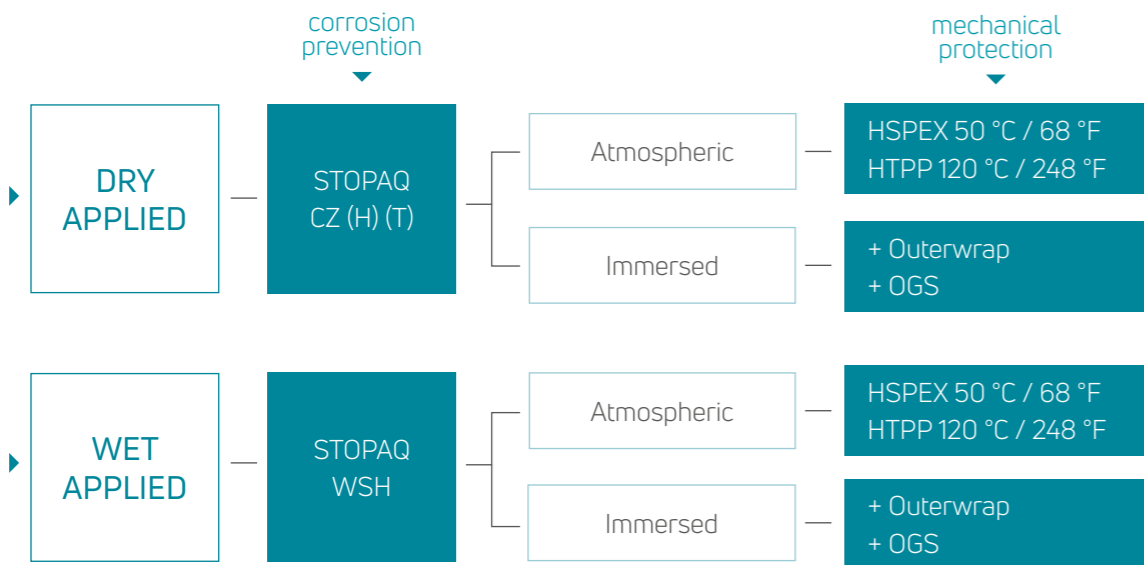

*Specialties are available for specific applications.



always
protected

Impact on the environment*

91%

carbon emission reduction

>99%

waste reduction

Non-hazardous to people and environment

3 x

extended lifetime

*Compared to traditional methods (blast & paint)

Total cost of ownership

Besides the costs of the coating itself one should also take into account additional costs and long term effects of the chosen coating. What are, for instance, the costs of surface preparation, application and the clean up? And what is the safety impact on the applicators and what will become the maintenance intervals?

When evaluating asset protection over a longer period of time it becomes clear that comparing STOPAQ to traditional methods, is in fact comparing apples and oranges.

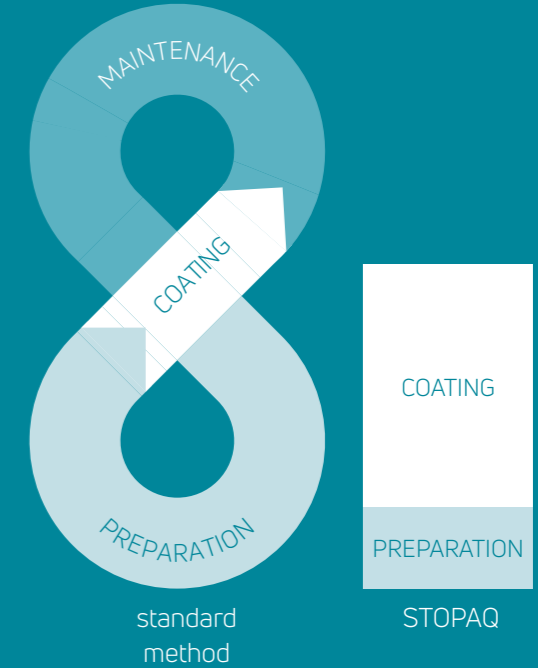



Self Healing Corrosion Prevention
& Sealant Technology



Printed on
100% recycled paper



rev. 001